

IMPLEMENTATION OF PARTICLE SWARM OPTIMIZATION BASED MACHINE LEARNING ALGORITHM FOR STUDENT PERFORMANCE PREDICTION

Muhammad Iqbal^{1*}; Irwan Herliawan²; Ridwansyah³; Windu Gata⁴; Abdul Hamid⁵; Jajang Jaya Purnama⁶; Yudhistira⁷

Ilmu Komputer^{1,2,4}, Teknik Informatika³, Sistem Informasi⁶
Sekolah Tinggi Manajemen Informatika dan Komputer Nusa Mandiri^{1,2,3,4,6}
www.nusamandiri.ac.id^{1,2,3,4,6}

14002390@nusamandiri.ac.id ^{1*}; 14002397@nusamandiri.ac.id ²; ridwansyah.rid@nusamandiri.ac.id ³;
windu@nusamandiri.ac.id ⁴; jajangja2412@bsi.ac.id ⁶

Teknologi Informasi⁵, Teknologi Komputer⁷
Universitas Bina Sarana Informatika^{5,7}
www.bsi.ac.id^{5,7}
hamid.adh@bsi.ac.id ⁵; yudhistira.yht@bsi.ac.id ⁷

(*) Corresponding Author

Abstract—Education plays an important role in the development of a country, especially educational institutions as places where the educational process has an important goal to create quality education in improving student performance. Based on research conducted in the last few decades the quality of education in Portugal has improved, but statistics show that the failure rate of students in Portugal is high, especially in the fields of Mathematics and Portuguese. On the other hand, machine learning which is part of Artificial Intelligence is considered to be helpful in the field of education, one of which is in predicting student performance. However, measuring student performance becomes a challenge since student performance has several factors, one of which is the relationship of variables and factors for predicting the performance of participating in an orderly manner. This study aims to find out how the application of machine learning algorithms based on particle swarm optimization to predict student performance. By using experimental research methods and the results of empirical studies shown in each model, namely random forest, decision tree, support vector machine, and particle swarm optimization based neural network can improve the accuracy of student performance predictions.

Keywords: Student Performance, Machine Learning, Particle Swarm Optimization, Prediction.

Intisari—Pendidikan memegang peranan penting terhadap perkembangan suatu negara terutama lembaga pendidikan sebagai tempat proses pendidikan mempunyai tujuan penting untuk menciptakan pendidikan yang berkualitas dalam meningkatkan kinerja siswa. Berdasarkan penelitian yang dilakukan dalam beberapa dekade terakhir kualitas pendidikan di Portugal mengalami peningkatan, namun secara statistik menunjukkan bahwa tingkat kegagalan siswa di Portugal yang tinggi khususnya pada bidang studi Matematika dan Bahasa Portugis. Disisi lain, *machine learning* yang merupakan bagian dari Kecerdasan Buatan dinilai dapat membantu dalam bidang pendidikan salah satunya dalam memprediksi kinerja siswa. Namun pengukur kinerja siswa menjadi sebuah tantangan sejak kinerja siswa memiliki beberapa faktor salah satunya hubungan variabel dan faktor untuk memprediksi kinerja berpartisipasi dengan cara tidak berurutan. Penelitian ini bertujuan untuk mengetahui bagaimana penerapan algoritma *machine learning* berbasis *particle swarm optimization* untuk memprediksi kinerja siswa. Dengan menggunakan metode penelitian eksperimen dan hasil studi empiris ditunjukkan pada masing-masing model yaitu *random forest*, *decision tree*, *support vector machine* dan *neural network* berbasis *particle swarm optimization* dapat meningkatkan akurasi prediksi kinerja siswa.

Kata Kunci: Kinerja Siswa, Machine Learning, Particle Swarm Optimization, Prediksi.

INTRODUCTION

Education plays an important role in the development of a country in improving standards

and ensuring the continuity of the life of an intelligent and cultured nation [1]. Meanwhile, the implementation of education is a shared responsibility, one of which plays an educational



role. Educational institutions as the place where the educational process takes place have an important goal to create quality education in improving student performance [2]. Student performance is an illustration of the ability of students to complete specific tasks given based on predetermined criteria [3]. Based on research by Paulo Cortez and Alice Silva that although the last few decades the quality of education in Portugal has improved, statistically it shows that the failure rate of students in Portugal is high. In 2006 the initial starting school level in Portugal was 40% for ages 18-24 years, while the European Union had an average grade of only 15%. Specifically, student failure is caused by a lack of student success in completing several fields of study, namely Mathematics and Portuguese [4].

In education predicting student performance becomes an important research topic that uses machine learning to explore data from the field of education [5]. Machine Learning is a computer science that studies how computers or machines have intelligence. Machine Learning also functions to optimize criteria or groupings by using data or experience [6]. On the other hand, Machine Learning which is part of Artificial Intelligence which aims to extract knowledge from data offers interesting automated tools that can analyze raw data for decision-makers who can help in the field of education, one of which is in predicting student performance [7]. Accurately predicting student performance in the early stages of learning helps in identifying weak students and enables

management to take corrective actions to prevent student failure [8].

Prediction of student performance in higher education has been identified as one of the important research topics in machine learning because it is considered to be able to analyze student academic behavior effectively and estimate its performance [9]. However, measuring student performance becomes a challenge since student performance depends on several factors, the relationship of variables and factors to predict the performance of participating in complicated non-sequential ways [5]. Information on student learning progress is also one of the factors of an educator's assessment in analyzing student performance, but the method is considered insufficient as an indicator of students and educators to make improvements in teaching and learning [10].

The main problem that existed in the previous research was that the value was still not optimal because there was no addition of existing attributes so that the student's assessment performance was still lacking, therefore the renewal of this study will improve these attributes with Particle Swarm Optimization Method. PSO is a population-based looping algorithm with lots of randomly initialized particles that can solve the optimization problem [11]. Particles will represent each candidate's solution and move towards an optimal position through search space that is adjusted for historical behavior [11]. The research literature used is as follows:

Table 1. Research Literature

Research Problem (RP)	Literatur Supports
RP1 Studen performance problems are an indicator of the assessment of accreditation results	Too many inactive students will influence the accreditation assessment [12]. Student performance problems are very complex because they can affect academic results [13].
RP2 The condition of student performance that is too early and unclear makes learning methods weak and slow	The unclear state of student performance results in slow and weak learning methods [14]. Student performance cannot be investigated early, causing delays in student graduation [15].
RP3 The number of factors and large data becomes the measurement of student performance	Large data sources are a difficult task for institutions to measure student performance [16]. Internal and external factors that can affect student performance in graduation [17].

Based on the above background, this study aims to determine how the application of machine learning algorithms in predicting PSO-based student performance using research methods in the form of experiments. To achieve this goal, it is necessary to do what factors affect student performance [18].

MATERIALS AND METHODS

In this study, the methodology used to develop predictive models using data mining is implemented following the CRISP-DM (Cross Industry Standard Process for Data Mining) model, where the process involves transforming business problems that predict student performance into

data mining problems. Furthermore, it involves data analysis including the collection and introduction of raw data and data preparation. Then, data modeling involving several prediction algorithms was developed, including Decision Tree, Random Forest, Neural Network, and Support Vector Machine. After the model is developed, the final step is to evaluate and test the model [13].



Figure 1. CRISP-DM Model

1. Business Understanding

By utilizing existing data sources, it can be analyzed and predicted using data mining techniques whose business objective is to make a classification on a machine learning algorithm based on particle swarm optimization to predict student performance.

2. Data Understanding

The data source used is student performance which is a dataset from the UCI Machine Learning Repository. The dataset was provided by the University of Minho in Portugal, collected during the 2005-2006 school year, using reports and questionnaires from two Portuguese high schools, determined in Mathematics. During the year, students are evaluated in two periods (G1, G2) and the third period combines the two previous periods to obtain the final results.

Table 1. Attributes, Data, and Data Descriptions

No	Attribute	Data	Data Description
1	School	MS/GP	MS: Mousinho da Silveira GP: Gabriel Pereira
2	Sex	M/F	M: Male F: Female
3	Age	15-22	
4	Address	R/U	R: Rural U: Urban

No	Attribute	Data	Data Description
5	Famsize	LE3/GT3	LE3: <=3 GT: >3
6	Pstatus	A/T	A: Apart T: Together
7	Medu	0/1/2/3/4	0: Nothing 1: Elementary School 2: Middle School 3: High School 4: Higher Education
8	Fedu	0/1/2/3/4	0: Nothing 1: Elementary School 2: Middle School 3: High School 4: Higher Education
9	Mjob	Teacher/Health/Service/ At home/Other	
10	Fjob	Teacher/Health/Service/ At home/Other	
11	Reason	Home/Reputation/ Course/Other	
12	Guardian	Mother/Father/Other	
13	Traveltime	1/2/3/4	1: <15 minutes 2: 15-30 minutes 3: 30 minutes-1 Hour 4: >1 Hour
14	Study-time	1/2/3/4	1: <2 hours 2: 2-5 hours 3: 5-10 hours 4: >10 hours
15	Failures	1/2/3/4	1: 1 time 2: 2 times 3: 3 times 4: 4 times
16	School-up	Yes/No	
17	Famsup	Yes/No	
18	Paid	Yes/No	
19	Activities	Yes/No	
20	Nursery	Yes/No	
21	Higher	Yes/No	
22	Internet	Yes/No	
23	Romantic	Yes/No	
24	Famrel	1/2/3/4/5	1: Very bad 2: Bad 3: Good 4: Great 5: Excellent
25	Freetime	1/2/3/4/5	1: Very low 2: Low 3: Normal 4: High 5: Very high
26	Goout	1/2/3/4/5	1: Very low 2: Low 3: Normal 4: High 5: Very high
27	Dalc	1/2/3/4/5	1: Very low 2: Low 3: Normal 4: High 5: Very high
28	Walc	1/2/3/4/5	1: Very low



No	Attribute	Data	Data Description
29	Health	1/2/3/4/5	2: Low 3: Normal 4: High 5: Very high 1: Very bad 2: Bad 3: Normal 4: Good 5: Very good
30	Absences	0-75	
31	Results	Pass/Fail	

The assessment method used in Portuguese education is a 20 point rating scale where zero indicates the lowest grade and 20 is the highest grade. The student performance dataset consists of 30 and 1 class.

3. Data Preparation

The preparation of the data aims that the data source can be applied in the modeling phase then it needs to be transformed. Models to be used are Random Forest, Decision Tree, Support Vector Machine, Neural Network.

4. Modeling

Modeling is done by developing models that have formed classification using binary classification approach and 5-level classification with Random Forest (RF) algorithm, Decision Tree (DT), Support Vector Machine (SVM) and Neural Network (NN) and apply Particle Swarm Optimization (PSO) to improve the accuracy of the student performance prediction model.

The binary classification and 5-level classification approach with the Random Forest algorithm

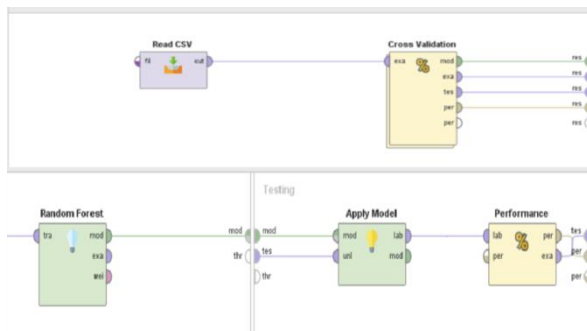

Figure 2. Testing binary classification and 5-level classification approaches with RF algorithm

From Figure 2 it can be explained that the student achievement dataset is validated and used by the Random Forest method. Binary classification approach and 5-level classification with PSO-based Random Forest algorithm

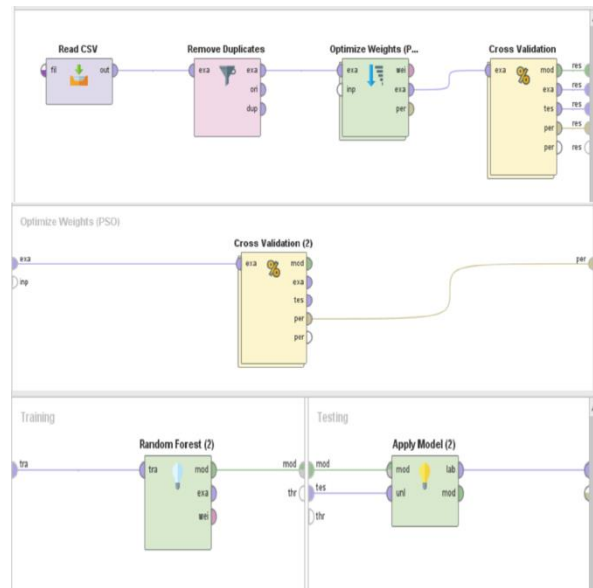

Figure 3. Testing binary classification and 5-level classification approaches with PSO-based RF algorithm

From Figure 3 it can be explained that the student performance dataset is the subject for duplicate data processing, after that the deletion process is carried out using the PSO method and validation using the Random Forest method with a binary classification approach and 5 level classification. Binary classification and 5-level classification approaches with the Decision Tree algorithm

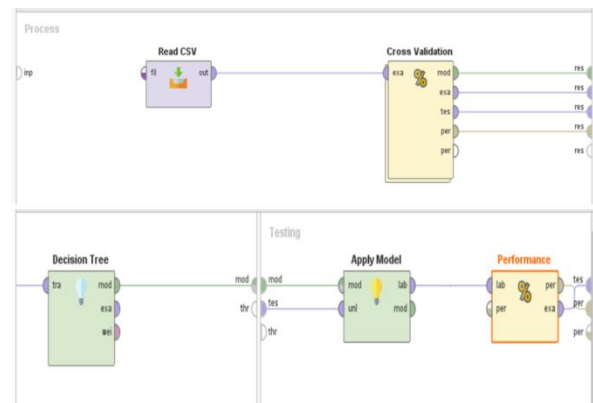

Figure 4. Testing binary classification and 5-level classification approaches with DT algorithm

From Figure 4 it can be explained that the student performance dataset is validated and uses the Decision Tree method with a binary classification approach and 5-level classification. The binary classification and 5-level classification approaches using the Particle Swarm Optimization-based Decision Tree algorithm

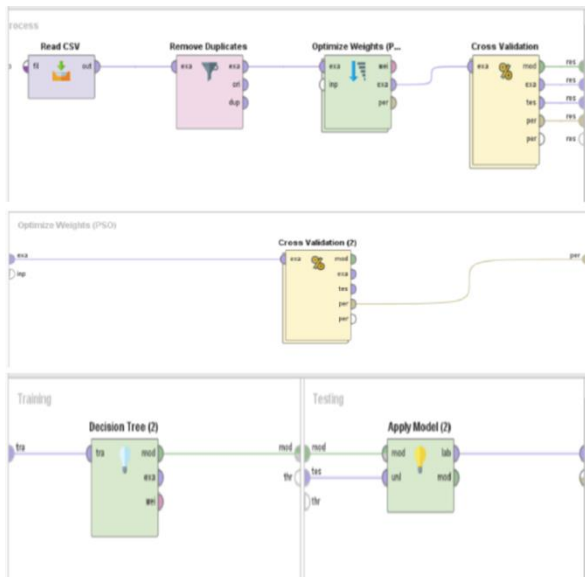

Figure 5. Testing binary classification and 5-level classification approaches with DT based PSO algorithm

From Figure 5, it can be explained that the duplicate data is removed from the student performance dataset after the deletion process is done using the PSO method and validation using the Decision Tree method with a binary classification approach and 5-level classification.

The binary classification and 5-level classification approach with the Support Vector Machine algorithm

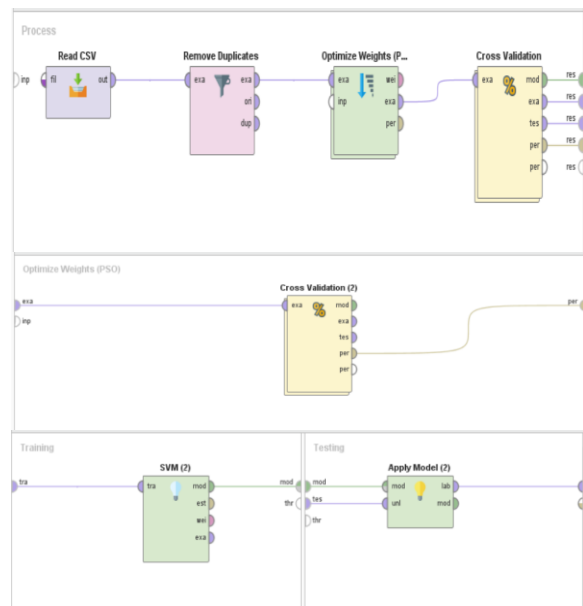

Figure 7. Testing binary classification and 5-level classification approaches with PSO-based SVM algorithm

From Figure 7 it can be explained that duplicate data is removed from the student performance dataset after the deletion process is carried out using the PSO method and validation using the Support Vector Machine method with a binary classification approach and 5 level classification. Binary classification and 5-level classification approaches with Neural Network algorithm

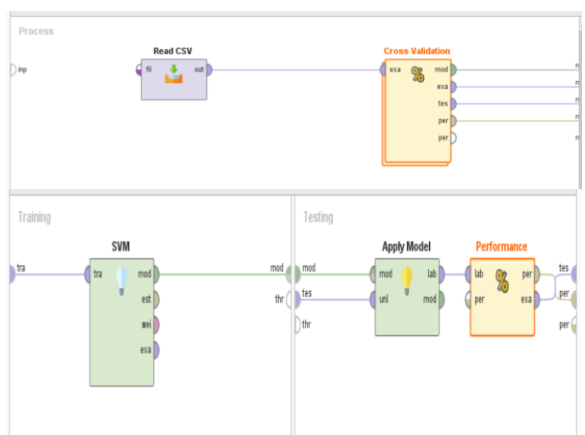

Figure 6. Testing binary classification and 5-level classification approaches with the SVM algorithm

From Figure 6 it can be explained that the student performance dataset is validated and uses the Support Vector Machine method with a binary classification approach and 5-level classification.

The binary classification and 5-level classification approaches using the Particle Swarm Optimization Support Vector Machine algorithm

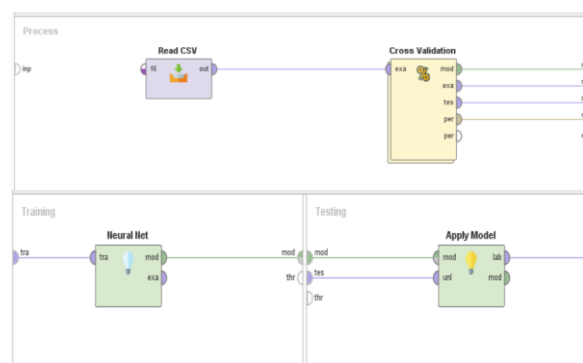

Figure 8. Testing binary classification and 5-level classification approaches with the NN algorithm

From Figure 8 it can be explained that the student performance dataset is validated and uses the Neural Network method with a binary classification approach and 5 level classification. The binary classification approach and 5-level classification with Neural Network algorithm based on Particle Swarm Optimization

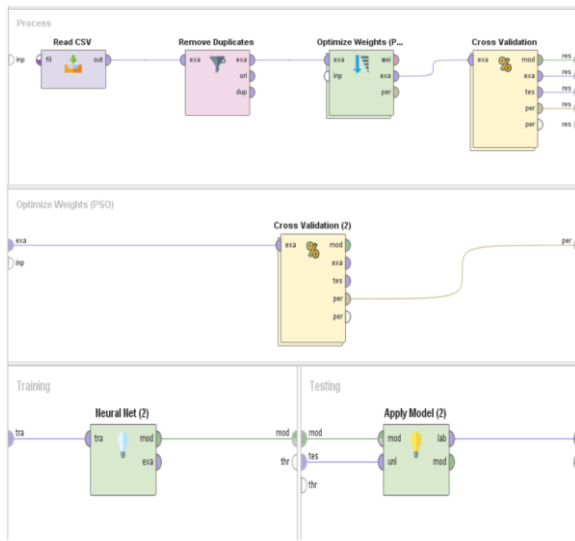

Figure 9. Testing the binary classification approach and 5-level classification with the PSO-based NN algorithm

From Figure 9, it can be explained that the duplicate data is removed from the student performance dataset after the deletion process is carried out using the PSO method and validation using the Neural Network method with a binary classification approach and 5-level classification.

RESULTS AND DISCUSSION

1. Evaluation

Evaluation is done using confusion matrix and Area Under Curve (AUC) techniques. The experimental results of testing the binary classification approach with the Random Forest (RF) algorithm based on Particle Swarm Optimization

PerformanceVector

```
PerformanceVector:
accuracy: 92.91% +/- 1.22% (micro average: 92.91%)
ConfusionMatrix:
True:  LULUS  GAGAL
LULUS: 538   35
GAGAL: 11   65
```

Figure 10. The experimental results of testing the binary classification approach with the PSO-based Random Forest (RF) algorithm

Figure 10 shows the results of the confusion matrix experiment testing the binary classification approach with the Random Forest algorithm based on Particle Swarm Optimization (PSO). Based on Figure 10, it can be seen that from 649 data, 538 predicted PASS, following predictions made by the

RF method, then 35 data predicted PASS, but it turns out the prediction results are FAILED. Then 65 data were predicted to FAIL, according to predictions made by the RF method, and 11 were predicted to be FAIL but the prediction was PASS.

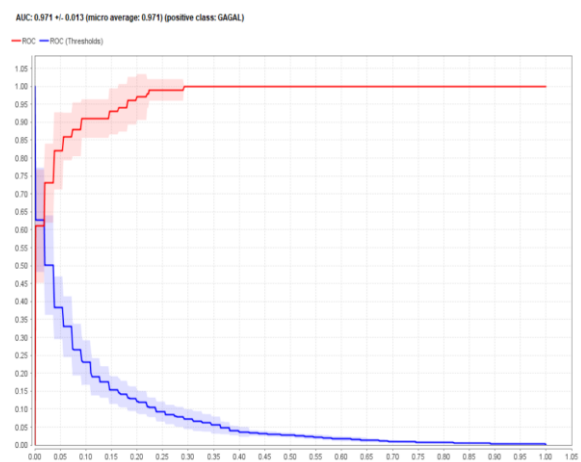

Figure 11. Area Under Curve (AUC) binary classification approach uses the PSO-based RF method

From Figure 11, the binary classification approach with the PSO-based Random Forest method produces an AUC of 0.971 with a very good classification. The experimental results of testing the binary classification approach with the Decision Tree (DT) algorithm based on Particle Swarm Optimization

PerformanceVector

```
PerformanceVector:
accuracy: 92.14% +/- 1.47% (micro average: 92.14%)
ConfusionMatrix:
True:  LULUS  GAGAL
LULUS: 529   31
GAGAL: 20   69
```

Figure 12. The results of the experimental testing of the binary classification approach with the PSO-based Decision Tree (DT) algorithm

Figure 12 shows the results of the confusion matrix experiment testing the binary classification approach with the Decision Tree algorithm based on Particle Swarm Optimization (PSO). Based on Figure 12, it can be seen that from 649 data, 529 predicted PASS, by predictions made by the DT method, then 31 data predicted PASS, but it turns out the prediction result is FAIL. Then 69 data were predicted to FAIL, according to predictions made by the DT method, and 20 were predicted to be FAIL but the prediction was PASS.

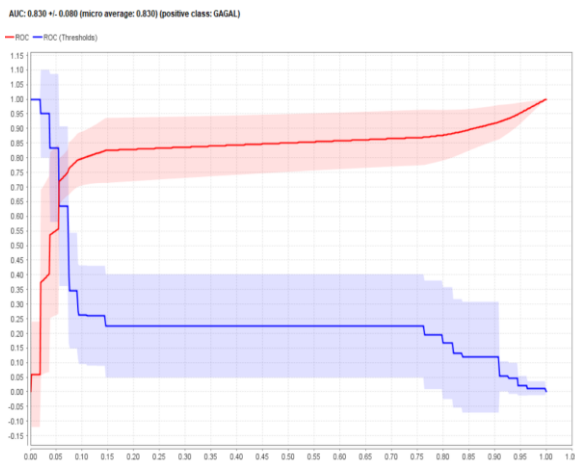

Figure 13. Area Under Curve (AUC) binary classification approach uses the PSO-based DT method

From Figure 13, the binary classification approach using the PSO-based Decision Tree method produces an AUC of 0.830 with a very good classification. The experimental results of testing the binary classification approach with the Support Vector Machine (SVM) algorithm based on Particle Swarm Optimization

PerformanceVector

PerformanceVector:
accuracy: 92.61% +/- 2.90% (micro average: 92.60%)
ConfusionMatrix:
True: 1 0
1: 536 35
0: 13 65

Figure 14. The experimental results of testing the binary classification approach with the PSO-based Support Vector Machine (SVM) algorithm

Figure 14 shows the results of the confusion matrix experiment that tested the binary classification approach with the Particle Swarm Optimization (PSO) algorithm based on Support Vector Machine. Based on Figure 14, it can be seen that out of 649 data, 536 data were predicted to be PASS, according to the predictions made by the SVM method, then 35 data were predicted to be PASS, but the prediction results were FAIL. Then 65 data were predicted to FAIL, according to the predictions made by the SVM method, and 13 data were predicted to FAIL but in fact, the predictions were PASS.

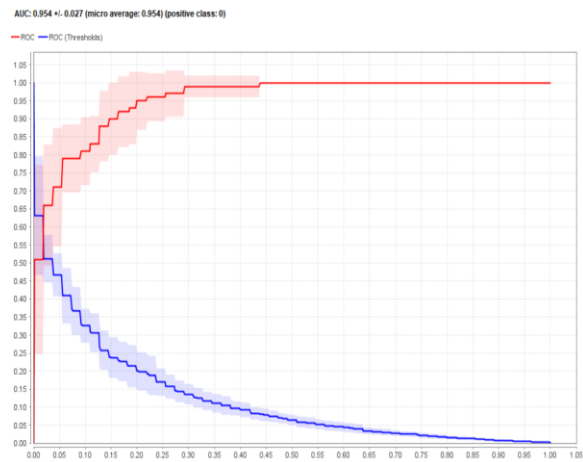

Figure 15 Area Under Curve (AUC) binary classification approach uses the PSO-based SVM method

From Figure 15, the binary classification approach with the PSO-based Support Vector Machine method produces an AUC of 0.954 with a very good classification. The experimental results of testing the binary classification approach with the Neural Network (NN) algorithm based on Particle Swarm Optimization

PerformanceVector

PerformanceVector:
accuracy: 89.98% +/- 2.44% (micro average: 89.98%)
ConfusionMatrix:
True: 1 0
1: 518 34
0: 31 66

Figure 16. The experimental results of testing the binary classification approach with PSO-based Neural Network (NN) algorithm

Figure 16 shows the results of the confusion matrix experiment testing the binary classification approach with the Particle Swarm Optimization (PSO) Neural Network algorithm. Based on Figure 16, it can be seen that from 649 data, 518 predicted PASS, by predictions made by the NN method, then 34 data predicted PASS, but it turns out the prediction result is FAIL. Then 66 data were predicted to FAIL, according to predictions made by the NN method, and 31 were predicted to FAIL but the prediction was PASS.

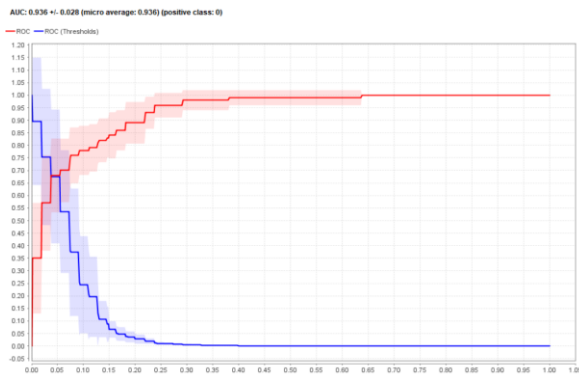

Figure 17. Area Under Curve (AUC) binary classification approach uses the PSO-based NN method

From Figure 17, the PSO-based Neural Network method binary classification approach produces an AUC of 0.936 with excellent classification. The experimental results of testing the 5-level classification approach with the Random Forest (RF) algorithm based on Particle Swarm Optimization

PerformanceVector

```
PerformanceVector:
accuracy: 75.20% +/- 6.15% (micro average: 75.19%)
ConfusionMatrix:
True:  D    C    B    A    E
D:    185   34    2    1   36
C:     3   117   40    0    1
B:     0    3   62   20    0
A:     0    0    8   61    0
E:    13    0    0    0   63
```

Figure 18. The experimental results of testing the 5-level classification approach with PSO-based Random Forest (RF) algorithm

Figure 18 shows the results of the confusion matrix experiment testing a 5-level classification approach with a Particle Swarm Optimization (PSO) based Random Forest algorithm.

The results of the experimental testing of the 5-level classification approach with the Decision Tree (DT) algorithm based on Particle Swarm Optimization

PerformanceVector

```
PerformanceVector:
accuracy: 72.26% +/- 4.99% (micro average: 72.27%)
ConfusionMatrix:
True:  D    C    B    A    E
D:    171   28    2    0   34
C:    10   111   37    0    1
B:     0   15   63   22    0
A:     0    0   10   59    0
E:    20    0    0    1   65
```

Figure 19. The experimental results of testing the 5-level classification approach with PSO-based Decision Tree (DT) algorithm

Figure 19 shows the results of a confusion matrix experimental testing of the 5-level classification approach with the Decision Tree algorithm based on Particle Swarm Optimization (PSO).

The results of experimental testing of the 5-level classification approach with the Particle Swarm Optimization-based Support Vector Machine (SVM) algorithm

PerformanceVector

```
PerformanceVector:
accuracy: 71.19% +/- 6.54% (micro average: 71.19%)
ConfusionMatrix:
True:  3    2    1    0    4
3:    177   29    6    1   46
2:    20   115   39    1    1
1:     0   10   65   28    0
0:     0    0    2   52    0
4:     4    0    0    0   53
```

Figure 20. The experimental results of testing the 5-level classification approach with the PSO-based Support Vector Machine (SVM) algorithm

Figure 20 shows the results of the confusion matrix experiment testing the binary classification approach with the Support Vector Machine based on Particle Swarm Optimization (PSO).

The results of experimental testing of the 5-level classification approach with the Neural Network (NN) algorithm based on Particle Swarm Optimization

PerformanceVector

```
PerformanceVector:
accuracy: 64.40% +/- 4.03% (micro average: 64.41%)
ConfusionMatrix:
True:  3    2    1    0    4
3:    149   35    5    1   29
2:    28   80   30    2    1
1:     1   36   56   16    0
0:     0    3   21   63    0
4:    23    0    0    0   70
```

Figure 21. The experimental results of testing the binary classification approach with the Neural Network (NN) algorithm based on Particle Swarm Optimization

Figure 21 shows the results of the confusion matrix experimental testing of the 5-level classification approach with the Particle Swarm Optimization (PSO) Neural Network algorithm.

2. Deployment

From the results of modeling and evaluation stages that have been obtained, it can be used to predict student performance.

CONCLUSION

In this study, binary classification and 5-level classification were tested using Random Forest, Decision Tree, Support Vector Machine, and Particle Optimization-based Neural Network models using rapid tools 9.0 on student performance datasets obtained from UCI Repository. The research results tested with a model with a binary classification approach using PSO-based Random Forest obtained an accuracy of 92.91% and AUC 0.971. While testing with the binary classification approach using Decision Tree based on Particle Swarm Optimization obtained an accuracy value of 92.14% with an AUC value of 0.830. Furthermore, testing using the binary classification approach using Support Vector Machine based on Particle Swarm Optimization obtained an accuracy value of 92.61% with an AUC value of 0.954. Finally testing using the binary classification approach using Neural Network based on Particle Swarm Optimization obtained an accuracy value of 89.98% with an AUC value of 0.936. The resulting model was tested to get the accuracy value of each algorithm so that testing with a 5-level classification approach using Random Forest based on Particle Swarm Optimization obtained an accuracy value of 75.20%. While testing with the 5-level classification approach using Decision Tree based on Particle Swarm Optimization obtained an accuracy value of 72.26%. Furthermore, testing with a 5-level classification approach using Support Vector Machine based on Particle Swarm Optimization obtained an accuracy value of 71.19%. Finally, testing using the 5-level classification approach using Neural Network based on Particle Swarm Optimization obtained an accuracy value of 64.40%. Based on these results which show that the results are quite good so that it can improve the accuracy of predictions of student performance.

REFERENCE

[1] R. H. Pambudi, B. D. Setiawan, and Indriati, "Penerapan Algoritma C4.5 Dalam Program Untuk Memprediksi Kinerja Siswa Sekolah Menengah," *Look Forward, Look Back Draw. Past To Shape Futur. Mark.*, 2018.

[2] H. Hamsa, S. Indiradevi, and J. J. Kizhakkethottam, "Student Academic Performance Prediction Model Using Decision Tree and Fuzzy Genetic Algorithm," *Procedia Technol.*, vol. 25, pp. 326-332, 2016.

[3] U. P. Indonesia, "Peningkatan Kinerja Siswa Melalui Pendekatan Saintifik Pada

Pembelajaran Ipa Terpadumodel Webbed," *J. Penelit. Pendidik*, vol. 17, no. 1, 2017.

[4] P. Cortez and A. Silva, "Using data mining to predict secondary school student performance," in *15th European Concurrent Engineering Conference 2008, ECEC 2008 - 5th Future Business Technology Conference, FUBUTEC 2008*, 2008.

[5] B. Guo, R. Zhang, G. Xu, C. Shi, and L. Yang, "Predicting Students Performance in Educational Data Mining," in *Proceedings - 2015 International Symposium on Educational Technology, ISET 2015*, 2016.

[6] T. Ginting and Y. E. Rohmadi, "Machine Learning untuk Localization Berbasis RSS Menggunakan CELL-ID GSM," *Teknomatika*, vol. 7, no. 2, p. 79, 2015.

[7] A. U. Khasanah and Harwati, "A Comparative Study to Predict Student's Performance Using Educational Data Mining Techniques," in *IOP Conference Series: Materials Science and Engineering*, 2017.

[8] M. Pandey and S. Taruna, "Towards the integration of multiple classifiers pertaining to the Student's performance prediction," *Perspect. Sci.*, vol. 8, pp. 364-366, 2016.

[9] G. Kostopoulos, A. D. Lipitakis, S. Kotsiantis, and G. Gravvanis, "Predicting student performance in distance higher education using active learning," in *Communications in Computer and Information Science*, 2017.

[10] F. Yang and F. W. B. Li, "Study on student performance estimation, student progress analysis, and student potential prediction based on data mining," *Comput. Educ.*, vol. 123, no. October 2017, pp. 97-108, 2018.

[11] A. Rachman and S. Wasiyanti, "Pengukuran Kualitas E-Commerce Shopee Terhadap Kepuasan Pengguna," *Paradig. J. Komput. dan Inform. Univ. Bina Sarana Inform.*, vol. 21, no. 2, pp. 143-148, 2019.

[12] S. Wiyono and T. Abidin, "IMPLEMENTATION OF K-NEAREST NEIGHBOUR (KNN) ALGORITHM TO PREDICT STUDENT'S PERFORMANCE," *Simetris J. Tek. Mesin, Elektro dan Ilmu Komput.*, 2018.

[13] W. F. W. Yaacob, S. A. M. Nasir, W. F. W. Yaacob, and N. M. Sobri, "Supervised data mining approach for predicting student performance," *Indones. J. Electr. Eng. Comput. Sci.*, 2019.

[14] M. Mohammadi, M. Dawodi, W. Tomohisa, and N. Ahmadi, "Comparative study of supervised learning algorithms for student performance prediction," in *2019*



- International Conference on Artificial Intelligence in Information and Communication (ICAIIIC)*, 2019, pp. 124-127.
- [15] E. P. Rohmawan, "Menggunakan Metode Decision Tree," *J. Ilm. Matrik Vol.20 No.1, April 2018* 21-30, pp. 21-30, 2018.
- [16] N. V. Krishna Rao, N. Mangathayaru, and M. Sreenivasa Rao, "Evolution and prediction of a radical multi-dimensional e-learning system with cluster-based data mining techniques," *Proc. - Int. Conf. Trends Electron. Informatics, ICEI 2017*, vol. 2018-Janua, pp. 701-707, 2018.
- [17] A. Rakhman, "Prediksi Ketepatan Kelulusan Mahasiswa Menggunakan Metode Decision Tree Berbasis Particle Swarm Optimization (PSO)," *Smart Comp Jurnalnya Orang Pint. Komput.*, vol. 6, no. 1, pp. 193-197, 2017.
- [18] Z. Ibrahim and D. Rusli, "Predicting Students' Academic Performance: Comparing Artificial Neural Network, Decision tree, And Linear Regression," *Proc. 21st Annu. SAS Malaysia Forum*, 2007.