

CONSTRUCTING MOODLE-BASED ONLINE LEARNING FOR VOCATIONAL SCHOOL

Dwinita Arwidiyarti^{1*}, Henni Comala Hikmi²

Information Technology Program¹, Administration Management Program²
Technology University of Mataram
<https://utmmataram.ac.id>
dwinita.arwidyaa@gmail.com¹, comala.hikmi@gmail.com²
(* Author Corresponding

Abstrak— During the Covid-19 pandemic, every level of educational institutions are demanded to employ online learning based on their condition and capability. Many efforts have been done to sustain the teaching and learning process without a face-to-face system. The characteristic of the learning model in vocational school is identical to education specified in the technical field which encompasses several fields of expertise and is passed down to expertise program and expertise competency which require an integrated system. One of the ways to meet the demand is constructing online learning with a learning management system based on Moodle (Modulator Object-Oriented Dynamic Learning Environment). This model aims to create an effective and integrated learning environment to create ease in observation and evaluation. This research used Zachman Framework which was started by determining the scope system encompassing data, process, and computer network configuration; designing a business model by using Use Case Diagram; designing the model of an information system by using Class Diagram, Activity Diagram, and Sequences Diagram; designing technology model by creating users' interface program; and proceed to the implementation by customizing the Moodle software to create Moodle-based online learning which can be used in vocational schools.

Keywords: Online Learning, Moodle (Modulator Object-Oriented Dynamic Learning Environment), Zachman Framework, Vocational Schools

Abstrak— Di masa Pandemi Covid-19 (Coronavirus Disease 2019) institusi pendidikan di semua tingkatan dituntut untuk dapat menerapkan pembelajaran daring sesuai dengan kondisi dan kemampuannya masing-masing. Berbagai cara dilakukan agar proses pembelajaran tetap dapat berjalan meskipun tanpa tatap muka di kelas. Karakteristik model pembelajaran pada Sekolah Menengah Kejuruan identik dengan pendidikan bidang keteknikan yang memiliki beberapa bidang keahlian yang diturunkan ke dalam program

keahlian dan kompetensi keahlian sehingga membutuhkan sebuah sistem yang terintegrasi. Salah satu cara yang dapat dilakukan untuk memenuhi kebutuhan tersebut adalah membangun pembelajaran daring dengan Learning Management System berbasis Moodle (Modulator Object-Oriented Dynamic Learning Environment). Tujuannya adalah agar proses pembelajaran dapat berjalan dengan efektif dan terintegrasi sehingga memudahkan dalam pengawasan dan evaluasi. Penelitian ini dilakukan dengan menggunakan pendekatan Zachman Framework dimulai dengan menentukan ruang lingkup sistem yang meliputi seluruh data dan proses yang dibutuhkan serta konfigurasi jaringan komputer; menentukan model bisnis dengan menggunakan Diagram Use Case; menentukan model sistem informasi dengan menggunakan Diagram Class, Diagram Activity dan Diagram Sequences; menentukan model teknologi dengan membuat rancangan tampilan antar muka pengguna, kemudian dilanjutkan dengan implementasi yaitu melakukan kustomisasi pada perangkat lunak Moodle sehingga diperoleh luaran berupa pembelajaran daring berbasis Moodle yang dapat digunakan di Sekolah Menengah Kejuruan.

Kata Kunci: Pembelajaran Daring, Moodle (Modulator Object-Oriented Dynamic Learning Environment), Zachman Framework, Sekolah Menengah Kejuruan

INTRODUCTION

Online learning is an innovation that has a major role in changing the learning process. Online learning is a form of learning which is compiled by using electronic or computer system connected with the network to support the teaching and learning process (Arthur-Nyarko, E., & Kariuki, 2019). Every single subject provides digital teaching materials including books, modules, and materials in the form of presentation or video along with weekly assessments which students should submit within a certain period and with various scoring systems. (Bilfaqih & Qomarudin,

2016). Online learning enables teachers to upload teaching materials in form of modules, presentations, videos, and assignments and allow students to access and do the assignment given by teachers through their smartphones without being bothered of attending schools (Zainuddin et al., 2016).

During the COVID-19 pandemic, educational institutions are urged to implement online learning based on their capability. A very long period of the pandemic has created a massive change in the learning process. SMK 2 Kuripan which is located in West Lombok, West Nusa Tenggara has also been affected. This school has eight areas of expertise with 1.257 students, 95 teachers, and 29 educators in the academic year 2019/2020. At the beginning of the Covid-19 pandemic, principals, in many schools, allowed their teachers to carry out the teaching and learning process through online media. Most teachers prefer to use the WhatsApp application to send teaching materials and assignments to their students and students submit their assignments and attendance through the application. In an emergency, there is nothing wrong with the use of the WhatsApp application in the implementation of online learning, but if this pandemic period lasts a long time and requires schools to hold a class for more than 1 semester, it will be ineffective. The teachers will find it difficult to record students who have or have not done the assignment and the school cannot evaluate the teaching and learning activities either in terms of the suitability with the schedule, the teaching materials, and the lesson plans, the number of students attending the class, the number of students doing the assignment and scores which are generated because they are not integrated (Gon & Rawekar, 2017). Therefore, to create an effective teaching and learning process during this pandemic, SMK 2 Kuripan needs an integrated Learning Management System which is accessible for both students and teachers.

Learning Management System is a software that is used to arrange and manage web-based online teaching materials (Aggilanda Easwary Muruthy & Fadhilah Mat Yamin, 2017). It is equipped with various features to assist students during the learning process which encompasses materials delivery, easiness in accessing the source of reference, assessment, online exam, feedback submission, and communication including online discussion, mailing list, and chats (Chourishi, 2015). Learning Management System has several features including Moodle (Modular Object-Oriented Dynamic Learning Environment). It is a web application used to create effective online learning (Isnaepi & Suparman, 2019). Teachers can manage teaching materials starting from uploading

teaching materials, giving assignments, receiving and responding to students' work, making quizzes or tests, conducting assessments, monitoring student participation, and interacting with fellow teachers and students, both in scientific forums and online discussions (Meza-Fernández & Sepúlveda-Sariego, 2017). LMS provides opportunities for teachers to develop learning materials (Santiago et al., 2020). The moodle-based learning management system has been widely used in higher education and secondary education even in training institutions with different modifications based on the conditions, readiness, and needs of each (Singh, 2016).

The characteristics of the learning model in Vocational Schools are identical to technical area education which is a simulation of technical problems in real situations. Some research on the implementation of Moodle in Vocational Schools has been carried out, for example, the implementation of Moodle-based online learning using the Problem Based Learning Method (Arifianto, 2017). This research was conducted in SMK Negeri 1 Pasuruan for students in grade X specialized in Computer and network techniques in computer assembly subjects. This research aimed to alleviate the teacher's role and increase students' activity in the learning process through the optimization of e-learning. Another research was conducted at SMK Nusatama Padang which was aimed to make Computer Skills and Information Management subject more interesting and easier to understand so that students can master the competency standards. The research is Moodle-Based E-Learning Design for teaching Computer Skills Learning and Information Management (Giatman et al., 2018). In the same year, B R Takaendengan and R H Santosa (Takaendengan & Santosa, 2018) carried out a study entitled Using Moodle to Improve Self-directed Learning of Mathematics in Vocational School. The observation was carried out on students of grade XI at SMK 1 Bitung to increase students' independence in learning mathematics. In 2020, a study entitled Development of E-Learning in Web Programming Subjects for Moodle-based Vocational Students (Wicaksono et al., 2020) sought to develop e-learning in the subjects of web programming (grade XI) Software Engineering Skills in Secondary Vocational High School Ibu Kartini Semarang.

The above-mentioned studies only focused on one subject, while online learning in SMK 2 Kuripan covers all subjects from grade X-XII which are divided into 14 expertise competencies with a total number of 44 classes. The goal is to achieve an integrated and effective teaching and learning

process and therefore facilitate the monitoring and evaluation process.

This research used the architectural Zachman Framework as the approach of information ((Zachman, 2003). Figure 1, the framework's phases are as follow:

MATERIALS AND METHODS

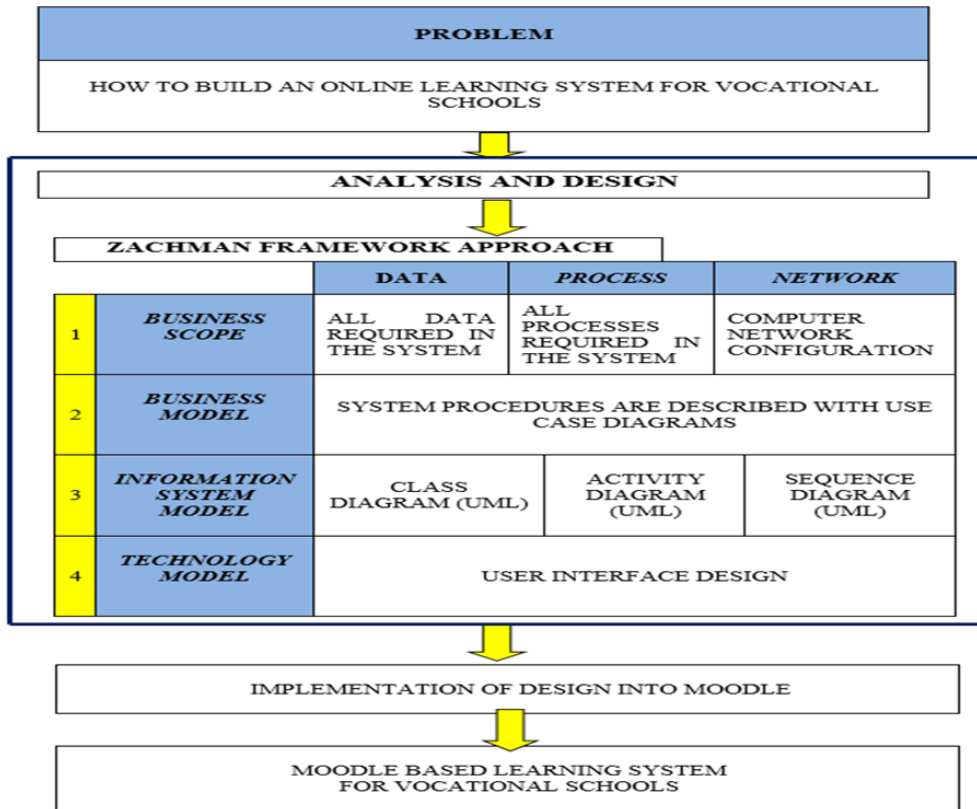

Source : (Arwidiyarti & Hikmi, 2020)

Figure 1. Research Phases of the Zachman framework

According to the framework, the phases are begun with identifying problems. The following phase is analyzing the problems and designing the appropriate approach by using the Zachman Framework. This step comprises determining the scale system which encompasses data, process, and configuration system followed by designing a business model using Use Case Diagram and eventually, designing an information system that is implemented in form of a Class Diagram, Activity Diagram, and Sequence Diagram. After that, it is necessary to construct a technology model that explains the users' interface model. The final step is implementing the online learning system into Moodle software.

RESULTS AND DISCUSSIONS

The stages are carried out by the Zachman Framework in Figure 1, as follows:

1. Determine the scope of the system (business scope) which includes all required data, processes, and computer network configurations that are required.

a. Need Analysis of Data and System

Need analysis is a vital stage in constructing an information system since it is directly related to the determination of the need system as a whole. Forum group discussion which involves the users such as vice curriculum, teachers, and system developers is used to figure out the needs and design of the system. It is necessary to design the need analysis. Data need analysis was also carried out to find out the data capacity during the implementation of a web-based learning management system. The needs of the data capacity can be seen in Table 1 below :

Table 1. The Need for Data and System

No.	Process name	Process description	Data Input	Actor
1	Login	User identification is needed to enter the system	Username, Password	Administrator, Teachers, Students
2	Registration	It is used to register the users	Teachers' data, students' data	Administrator
3	Enrollment Key	It is used as a code to access the subjects	Enrollment key of every single subject	Teachers, Students
4	Data management	It is used to manage the data of the area of expertise, expertise program, expertise competence, semester, classes, and subjects	Data	Administrator
5	Upload teaching materials	It is used to upload teaching materials into the system	Teaching materials, video	Teachers
6	Download teaching materials	It is used to download teaching materials uploaded by teachers	Teaching materials, video	Students
7	Upload assignment	It is used to upload assignment into the system	Assignment	Students
8	Download assignment	It is used to download assignment uploaded by teachers	Assignment	Teachers
9	Upload the result of an assignment	It is used to upload the result of the assignment into the system	Assignment result	Students
10	Download the result of an assignment	It is used to download the result of an assignment	Assignment result	Teachers
11	Upload quiz	It is used to upload quiz into the system	Quiz	Teachers
12	Join The Quiz	It is used by students to do the quiz	Quiz result	Students
13	Giving score	It is used to give score upon students' assignment and quiz	Assignment score, quiz score	Students
14	Preview score	It is used by students to find out the score of quiz and assignment	Assignment score, quiz score	Teachers
15	Live chat	It is used to check students' presence	Students' data	Teachers, Students
16	Access Forum	It is used as a medium of discussion	Question and answer	Teachers, Students

Source : (Arwidiyarti & Hikmi, 2020)

b. Computer Network Configuration

The implementation of the Moodle-based learning management system will be developed in an online model with web server software that has domain address and public IP so that users can access it through the internet with a computer network configuration can be seen in Figure 2.

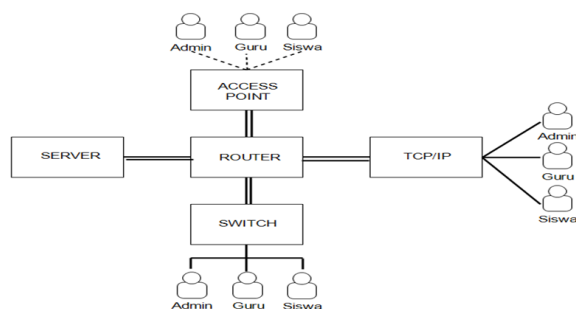

Source : (Singh, 2016)

Figure 2. Computer Network Configuration

2. Design a business model, namely the system management described by the Use Case Diagram

Use Case Diagram describes what the system is working on. There are three actors in this system namely administrator, teacher, and student. The use case explains what the actor does with the *relation* menu as the pointer. Use Case Diagram is shown in Figure 3.



Source : (Arwidiyarti & Hikmi, 2020)

Figure 3. Use Case Diagram

3. Creating an information system model in the form of Class Diagrams, Activity Diagrams, and Sequence Diagrams.

a. Class Diagram

The classes, the relationship between one class and another, and their attributes are described in the Class Diagram. The description is in Figure 4 below:

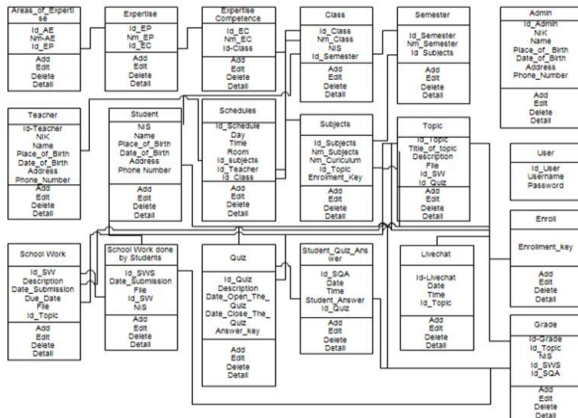

Source: (Arwidiyarti & Hikmi, 2020)
Figure 4. Class Diagram

b. Activity Diagram

Activity diagrams are used to describe the sequence of business process activities. The following is one of the activities diagrams which are made. The Activity Diagram is shown in Figure 5.

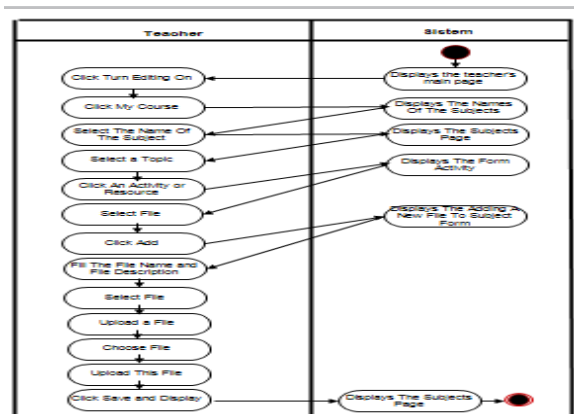

Source: (Arwidiyarti & Hikmi, 2020)
Figure 5 Activity Diagram: Adding Teaching Materials to a Topic.

c. Sequence Diagram

Sequence diagrams are used to show the interactions of objects arranged in a sequence of time. The following is one of the Sequence Diagrams which are made. The sequence diagram is shown in Figure 6.

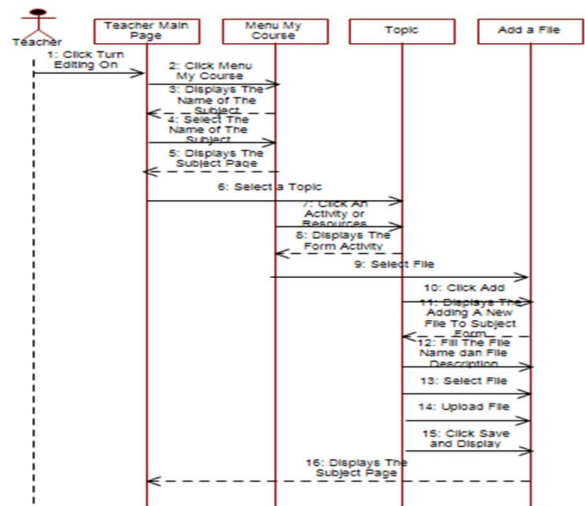

Source: (Arwidiyarti & Hikmi, 2020)
Figure 6 Sequence Diagram: Adding Teaching Materials to a Topic by The Teacher

4. Creating a technology model in the form of interface design.

The interface design is made for each screen display, functioning as a communication medium between the user and the system.

5. Implementing the design into Moodle

The following are some examples of the display provided on the Learning Management System.

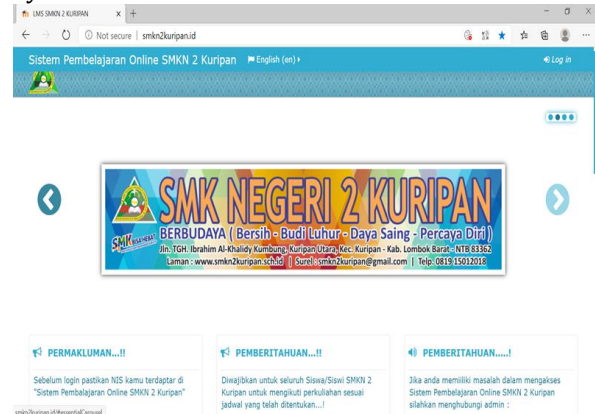

Source : (Arwidiyarti & Hikmi, 2020)
Figure 7. Interface Display on Main Page

Figure 7 above is the main screen display of the LMS which displays announcements and log in facilities for users.

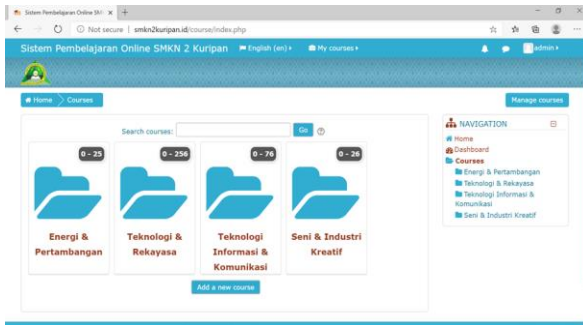

Source : (Arwidiyarti & Hikmi, 2020)
 Figure 8. Administrator Interface Display on Expertise Field Management Page

Figure 8 displays the administrator interface on the expertise management page. Administrators are tasked with managing areas of expertise according to the number and names of areas of expertise owned by the school. This activity is carried out by administrators in the early stages of using the LMS or if there are additions to areas of expertise.

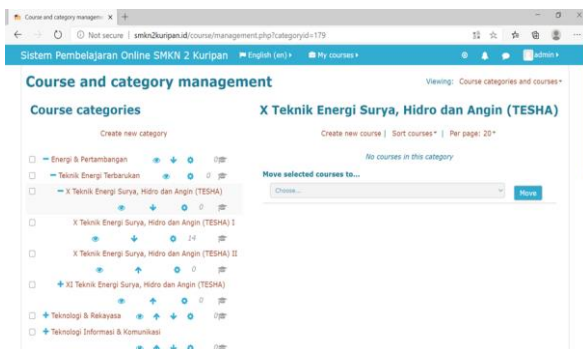

Source : (Arwidiyarti & Hikmi, 2020)
 Figure 9. Administrator Interface Display on Class Management Page

Figure 9 displays the administrator interface on the class management page. Class management is carried out by administrators at the beginning of each new academic year, namely by adding the number of classes in each field of expertise for both class X, XI, and class XII.

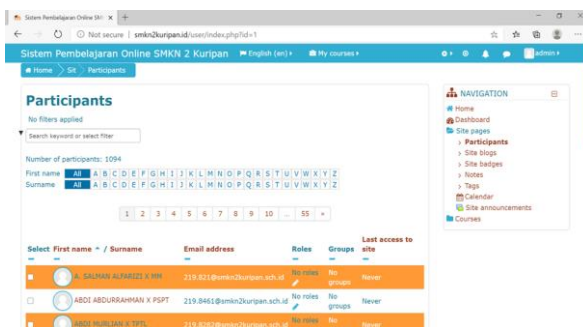

Source : (Arwidiyarti & Hikmi, 2020)
 Figure 10. Administrator Interface Display on Register User Page

Figure 10 displays the Administrator Interface on the User Registration Page. This page is used by

administrators to register users, namely teachers and students so that they can log into the LMS.

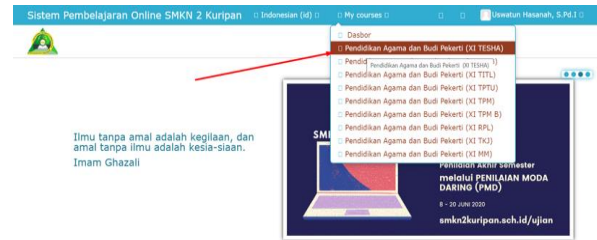

Source (Arwidiyarti & Hikmi, 2020)
 Figure 11. Teachers Interface Display on List of Subjects Page

Figure 11 displays the teacher interface on the subject list page. On this page will appear all the subjects taught by each teacher.

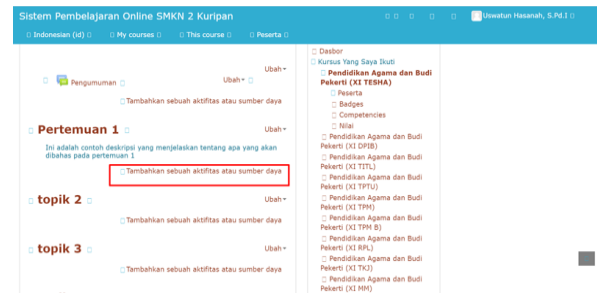

Source : (Arwidiyarti & Hikmi, 2020)
 Figure 12. Teachers Interface Display on Add Teaching Materials Page

Figure 12 shows the teacher interface on the add teaching materials page. The teacher can add topics to each subject being taught, besides that the teacher can also add teaching materials in the form of files, electronic books, teaching videos, assignments, live chat, and quizzes in various forms.



Source : (Arwidiyarti & Hikmi, 2020)
 Figure 13. Teachers Interface Display on List of Uploaded Assignments Page

Figure 13 displays the teacher interface on the uploaded task list page. The teacher can see how many students have uploaded assignments, downloaded assignments, gave grades, and

comments on assignments that have been done by students.

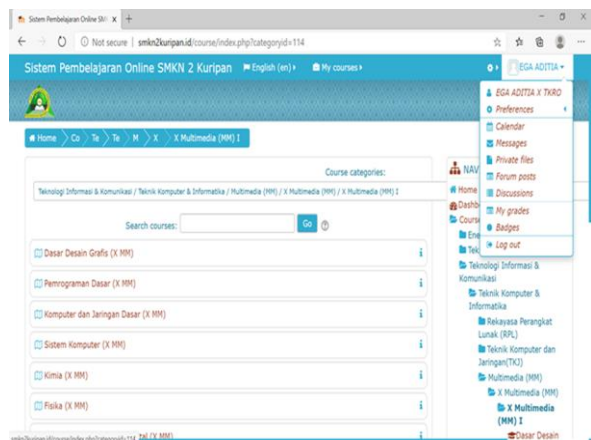

Source : (Arwidiyarti & Hikmi, 2020)
 Figure 14. Students Interface Display on List of Subjects Followed Page

Figure 14 shows the Student Interface on the Following Subject List Page. In this interface, students can see a list of subjects that are followed in the semester.



Source : (Arwidiyarti & Hikmi, 2020)
 Figure 15. Students Interface Display on Learning Materials Page

Figure 15 displays the student interface on the learning materials page. In this interface, students can see the subject matter for all the subjects they take in that semester. The subject matter is presented per topic. In each topic, there are teaching materials in the form of files, electronic books, teaching videos, assignments, quizzes, and live chat.

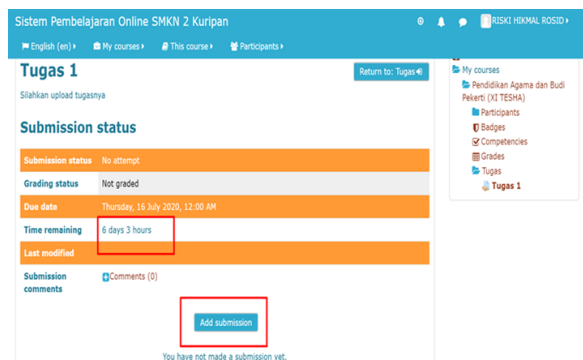

Source : (Arwidiyarti & Hikmi, 2020)
 Figure 16. Students Interface Display on Task Page

Figure 16 displays the student interface on the assignment page. On this page, students can see the assignments they have to do and the deadline for uploading assignments to the LMS.

CONCLUSION

According to the results and discussion, it can be concluded that teachers can create an effective and integrated online learning process by using an appropriate learning system that can be developed, one of which by installing open source-based Moodle application. To accommodate the needs in all fields of expertise, this application is highly important to be applied in SMK 2 Kuripan. The use of the Zachman framework in design makes it easier to analyze data, process and network requirements (business scope), determine the business model, information system model, and technology model to be implemented and so it will produce an LMS that suits the needs of students at SMK 2 Kuripan. Furthermore, the Moodle system allows users to integrate and record the whole teaching and learning activities and therefore make supervision and evaluation much easier. After the Covid-19 pandemic ends, this LMS can still be used as blended learning which will support face-to-face learning in class.

REFERENCES

Aggilanda Easwary Muruthy, & Fadhilah Mat Yamin. (2017). The Perception and Effectiveness of Learning Management System (LMS) Usage Among The Higher Education Student. *Journal of Technology and Operations Management*, 12(1), 86–98. <https://doi.org/https://doi.org/10.32890/jtom2017.12.1.9456>

Arifianto, T. (2017). Penerapan E-Learning Berbasis Moodle Menggunakan Metode

- Problem Based Learning di SMK Negeri 1 Pasuruan. *Smatika Jurnal*, 7(2), 01–07. <http://jurnal.stiki.ac.id/index.php/SMATIKA/article/view/151>
- Arthur-Nyarko, E., & Kariuki, M. G. (2019). Learner access to resources for eLearning and preference for eLearning delivery mode in distance education programs in Ghana. *International Journal of Educational Technology*, 6(2), 1–8.
- Arwidiyarti, D., & Hikmi, H. C. (2020). *Laporan Pengabdian kepada Masyarakat : Membangun Pembelajaran Daring Bagi Guru dan Siswa di SMK Negeri 2 Kuripan*.
- Bilfaqih, Y., & Qomarudin, M. N. (2016). *Esensi penyusunan materi pembelajaran daring : panduan berstandar penyusunan materi pembelajaran daring untuk pendidikan dan pelatihan* (I). Deepublish.
- Chourishi, D. (2015). Effective E-Learning through Moodle Moodle for E-learning. *International Journal of Advanced Technology & Engineering Research (IJATER)*, 1(March 2012), 34–38.
- Gon, S., & Rawekar, A. (2017). Effectivity of E-Learning through Whatsapp as a Teaching-Learning Tool. *MVP Journal of Medical Sciences*, 4(1), 19. <https://doi.org/10.18311/mvpjms/0/v0/i0/8454>
- Isnaepi, & Suparman. (2019). Design of MOODLE-based mathematics learning to improve spatial ability for class xii high school students. *International Journal of Scientific and Technology Research*, 8(10), 1174–1177.
- Meza-Fernández, S., & Sepúlveda-Sariego, A. (2017). Representational model on Moodle's activity: learning styles and navigation strategies. *International Journal of Educational Technology in Higher Education*, 14(1). <https://doi.org/10.1186/s41239-017-0052-3>
- Santiago, B. J., Ramírez, J. M. O., Rodríguez-Reséndiz, J., Dector, A., García, R. G., González-Durán, J. E. E., & Sánchez, F. F. (2020). Learning Management System-based Evaluation to Determine Academic Efficiency Performance. *Sustainability (Switzerland)*, 12(10), 1–17. <https://doi.org/10.3390/su12104256>
- Singh, E. G. (2016). Moodle as an E-Learning Approach for Training and Education. *International Journal of Innovative Research in Computer and Communication Engineering*, 17163–17168. <https://doi.org/10.15680/IJIRCCE>
- Takaendengan, B. R., & Santosa, R. H. (2018). Using moodle to improve self-directed learning of mathematics in a vocational school. *Journal of Physics: Conference Series*, 1097(1), 0–6. <https://doi.org/10.1088/1742-6596/1097/1/012121>
- Wicaksono, A., Florentinus, T. S., & Ahmadi, F. (2020). Development of E-Learning in Web Programming Subjects for Moodle Based Vocational Students. *Innovative Journal of Curriculum and Educational Technology*, 9(1), 1–9. <https://journal.unnes.ac.id/sju/index.php/ujet/article/view/33095>
- Zachman, J. A. (2003). *The Zachman Framework For Enterprise Architecture: Primer for Enterprise Engineering and Manufacturing*. Zachman International.
- Zainuddin, N., Idrus, R., & Jamal, A. F. M. (2016). Moodle as an ODL teaching tool: A perspective of students and academics. *Electronic Journal of E-Learning*, 14(4), 282–290.